

SINGAPORE CHINESE GIRLS' SCHOOL (PRIMARY)

NAME: _____ ()

DATE:

CLASS: PRIMARY 4 SY / C / G / SE / P

Parent's Signature:

SCIENCE
BOOKLET A

28 questions

56 marks

Total time for Booklets A & B: 1 h 45 min

DO NOT OPEN THIS BOOKLET UNTIL YOU ARE TOLD TO DO SO.

FOLLOW ALL INSTRUCTIONS CAREFULLY.

Part I (56 marks)

For each question from 1 to 28, four options are given. One of them is the correct answer. Make your choice (1, 2, 3 or 4). **Shade the correct oval (1, 2, 3 or 4) on the Optical Answer Sheet.**

1. Which one of the following is a living thing?

1)

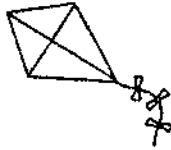

3)



2)

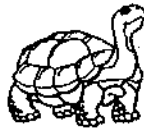

4)

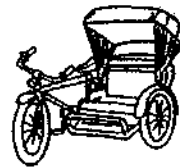

2. Which one of the following is not a source of heat?

1) The Sun

3) A candle flame

2) A lighted bulb

4) A woollen sweater

3. Which one of the following properties is true for both air and a pen?

1) They have definite volumes.

2) They can be seen.

3) They take up space.

4) They have definite shapes.

4. Which one of the animals shown below is not an insect?

1)



3)



2)



4)



5. A, B, C and D are the various stages in the life cycle of a mosquito.

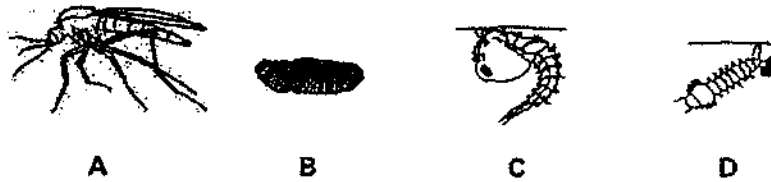

Which of the following correctly shows the life cycle of a mosquito?

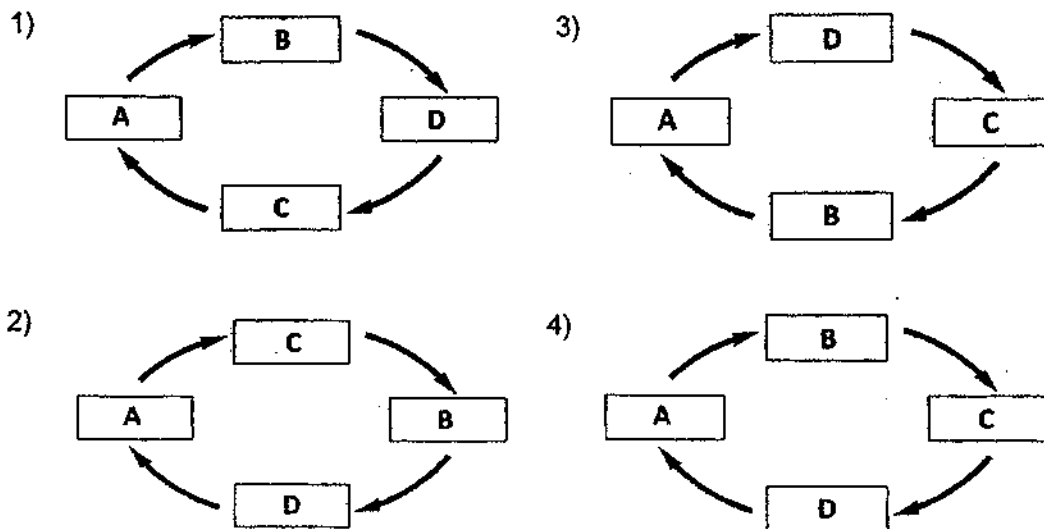

6. The diagram shows a plant.
Which part, 1, 2, 3 or 4 is the stem?

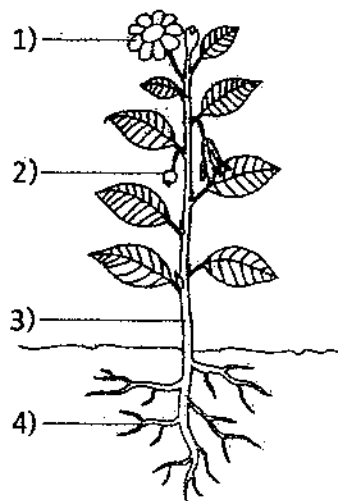

7. In which one of the following will the two magnets push each other away?

1)

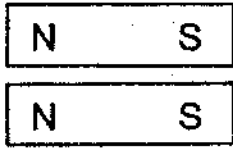

2)

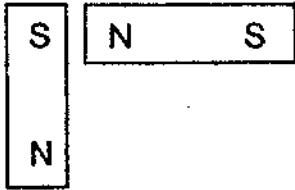

3)



4)

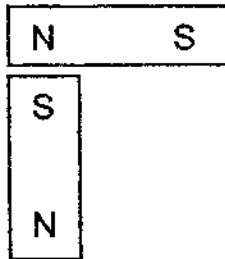

8. Which one of the following is a source of light?

1)



A campfire

3)



The moon

2)



An apple

4)



A twig

9. The diagram shows a clock hanging on a wall on a nail.

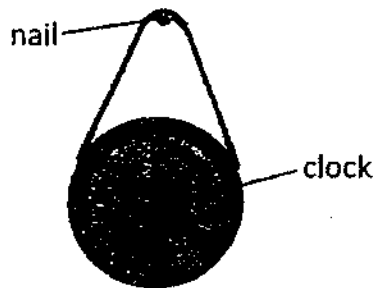

Iron is used to make nails because iron _____.

- 1) is shiny
- 2) is strong
- 3) sinks in water
- 4) conducts heat well

10. Alvin wants to measure the temperature of hot water in a beaker.

Which one of the following diagrams shows the correct position of the thermometer when taking the temperature reading?

1)

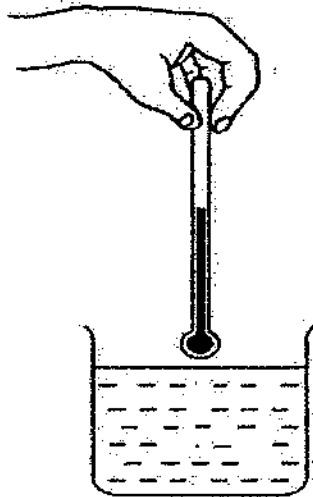

3)

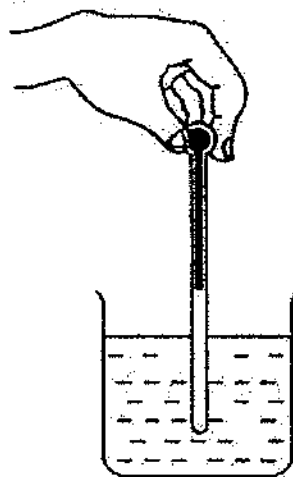

2)

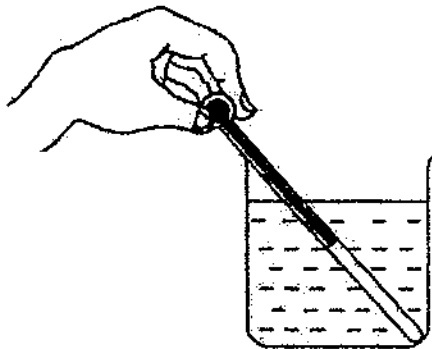

4)

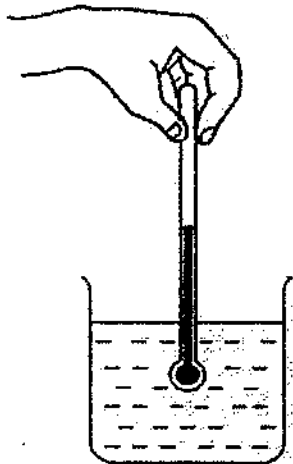

11. Which of the following systems work together so that the whole body can receive oxygen?

- 1) Circulatory and digestive system
- 2) Digestive and muscular system
- 3) Circulatory and respiratory system
- 4) Respiratory and muscular system

12. Which one of the following graphs shows the change in height as the seedling grows into an adult plant?

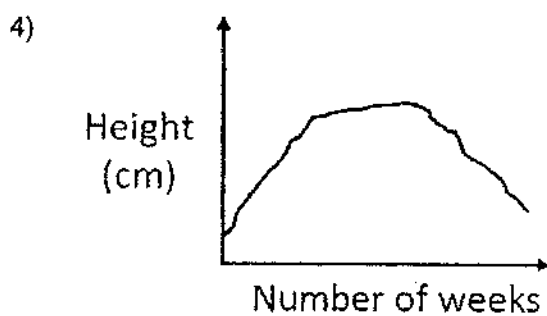
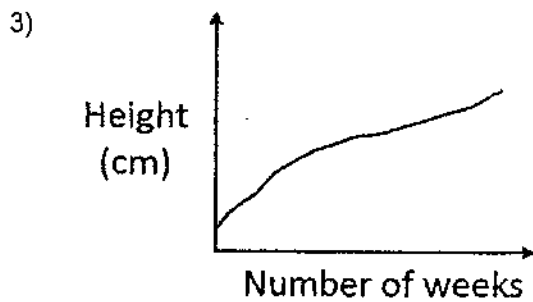
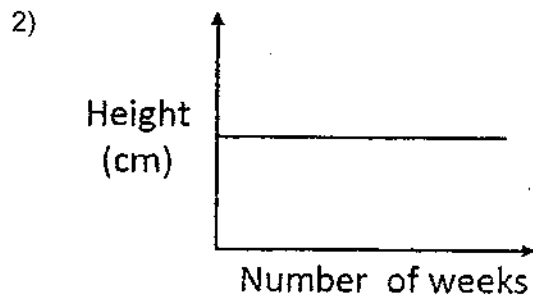
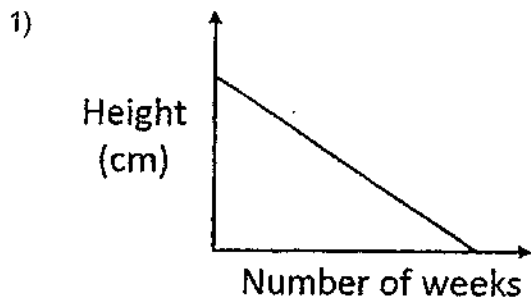

13. What is/are the common property/properties of the objects shown below?



Grocery bag

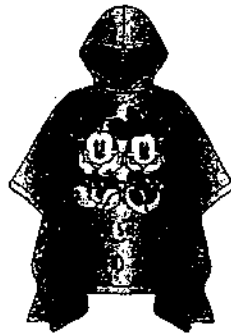

Raincoat



Hair tie

- A: They are light.
- B: They are hard.
- C: They are flexible.

- 1) A only
- 2) B only
- 3) A and B only
- 4) A and C only

14. Wen Juan placed a light sensor in a **completely dark room**. She shone torch E at the light sensor and recorded the results in the table below. She then repeated the experiment with three torches, F, G and H.

Torch	Intensity of light in room when the torch was switched off (Lux)	Intensity of light in room when torch was switched on (Lux)
E	0	60
F	0	45
G	0	20
H	0	45

Which one of the following statements correctly explains Wen Juan's observations?

- A: Torch E is bigger than Torch H.
- B: Torch E is brighter than Torch G.
- C: Torch F and Torch H are equally bright.

- 1) A and B only
- 2) B and C only
- 3) A and C only
- 4) A, B and C

15. Study the flow chart below.

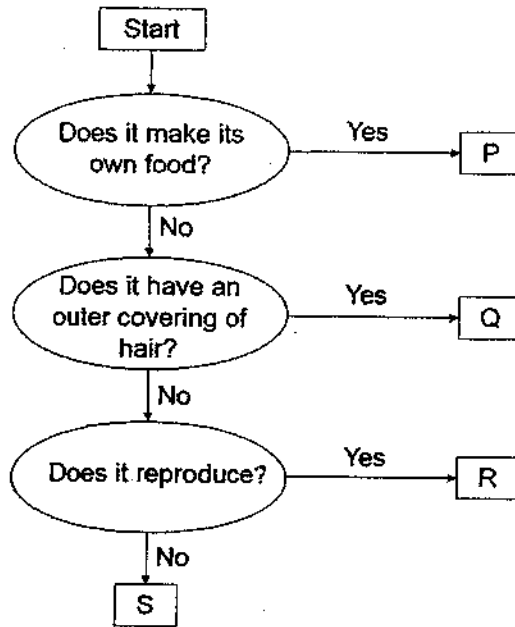

What conclusions can be made from the information given?

- A: P is a plant.
- B: Q is a mammal.
- C: R may be a fungi.
- D: S is not a living thing.

- 1) A and B only
- 2) B and C only
- 3) A, B and D only
- 4) A, B, C and D

16. Linda had four magnets, D, E, F and G. To compare the strength of the magnets, she brought each of the magnets near a pile of pins.

The table below shows the number of pins attracted by the magnets, D, E, F and G, from various distances.

Magnet	Distance between magnet and pins (cm)	Number of pins attracted
D	4	11
E	3	11
F	5	10
G	3	12

Which one of the following statements is definitely correct?

- 1) Magnet D is as strong as magnet E.
 - 2) Magnet F is the strongest magnet.
 - 3) Magnet G is stronger than Magnet E.
 - 4) Magnet D is weaker than Magnet G.
17. Four similar spoons were used to hold an object each as shown in the diagram below.



Substance A



Substance B



Substance C



Substance D

Which one of the following substances is most likely not a solid?

- 1) Substance A
- 2) Substance B
- 3) Substance C
- 4) Substance D

18. Muthu conducted an experiment. He placed two identical homemade biscuits on the table. He sprinkled some water on one of the biscuits.

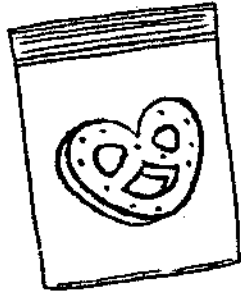

biscuit sprinkled
with water



biscuit with no
water sprinkled

Three days later, Muthu noticed that the piece of biscuit that was sprinkled with water had mould on it. The piece of biscuit with no water sprinkled on it did not have any mould.

What can Muthu conclude from the experiment?

- 1) Mould can make their own food.
- 2) Mould grow better in damp places.
- 3) Mould needs sunlight, water and air to survive.
- 4) Living things can reproduce faster than non-living things.

19. Which of the following objects most likely use magnets to work?

- A: Compass
- B: Refrigerator
- C: Electric Iron
- D: Electric kettle
- E: Scrap iron crane

- 1) A, B and C only
- 2) A, B and E only
- 3) B, C and D only
- 4) B, C and E only

20 What will happen to the iron rod if it is stroked thirty times by each of the two magnets?

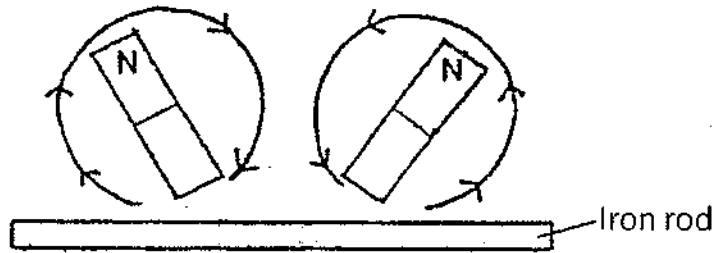

The iron rod will _____.

- 1) not become a magnet
- 2) become a magnet with two different poles
- 3) become a magnet with two north-seeking poles
- 4) become a magnet with two south-seeking poles

21. When Ginny reached home on a hot day, she realised that the tiles on her floor in her home had buckled.

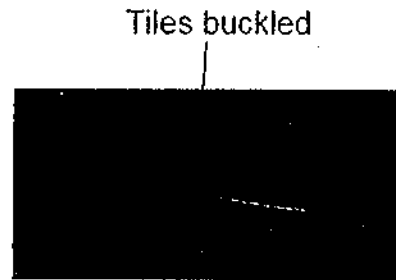

The tiles buckled because the _____.

- 1) tiles contracted too much
- 2) gaps between the tiles were too big
- 3) rates of expansion between the tiles were different
- 4) tiles were of different shapes

22. Issac wanted to find out which materials allowed light to pass through using the following set-up as shown below.

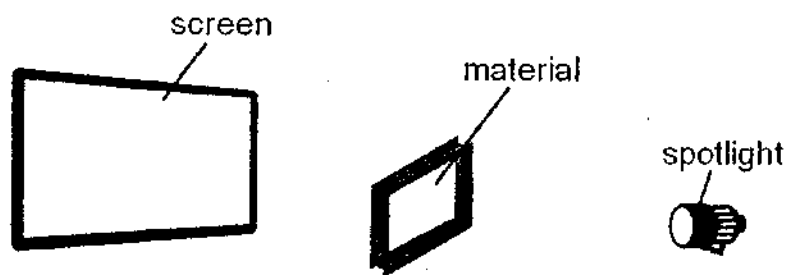

Which of the following variables should he keep the same in order to conduct a fair test?

- A: Type of material
- B: Thickness of material
- C: Distance between the material and the screen

- 1) B only
- 2) A and B only
- 3) A and C only
- 4) B and C only

23. Dynamic Rope Company produces ropes for all purposes.

A climber made a list of the type of rope she needs:

- It can be coiled up easily.
- It will not weigh her down.
- It will not break if she falls.

The table below shows 4 types of ropes that the company produces and their properties.

Property \ Rope	Apex	Beta	Delta	Kappa
Flexibility	High	Low	Medium	Low
Weight	Low	Medium	Low	Low
Strength	High	High	Low	High

Which rope should the climber purchase?

- 1) Apex
- 2) Beta
- 3) Delta
- 4) Kappa

24. Ronaldo set up an experiment using similar balloons, basins and conical flasks as shown below.

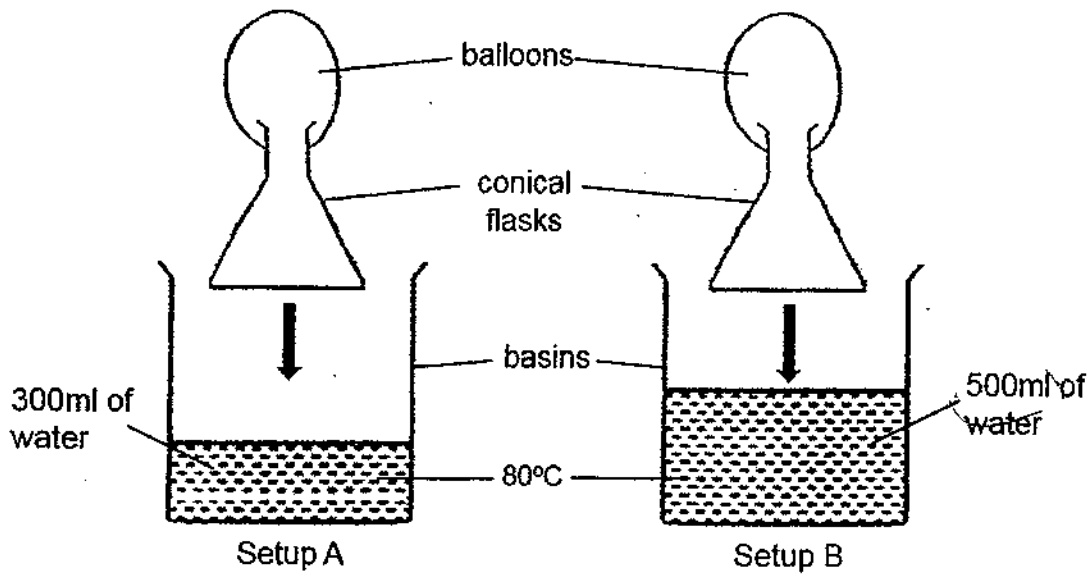

After five minutes, the balloon in setup B was more inflated than the balloon in setup A.

Which one of the following conclusions could Ronaldo make from his experiment?

- 1) Colder water was used in setup A than in setup B.
- 2) Water in setup B contained more heat than the water in setup A.
- 3) The conical flask in setup A lost more heat than the one in setup B.
- 4) The conical flask in setup B conducted heat faster than the one in setup A.

25. Which of the following torch positions would create an oval shadow of the 20-cent coin on the screen?



20-cent coin

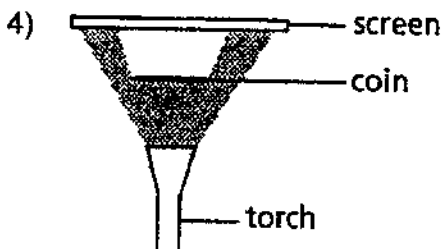
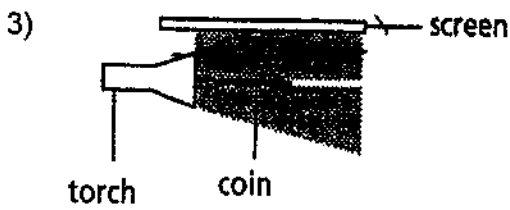
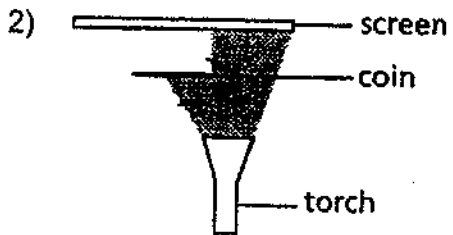
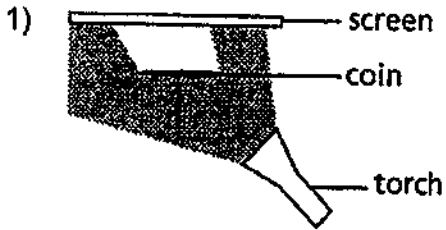

27. Iris put a beaker of water with ice cubes in an air-tight box as shown in the diagram below.

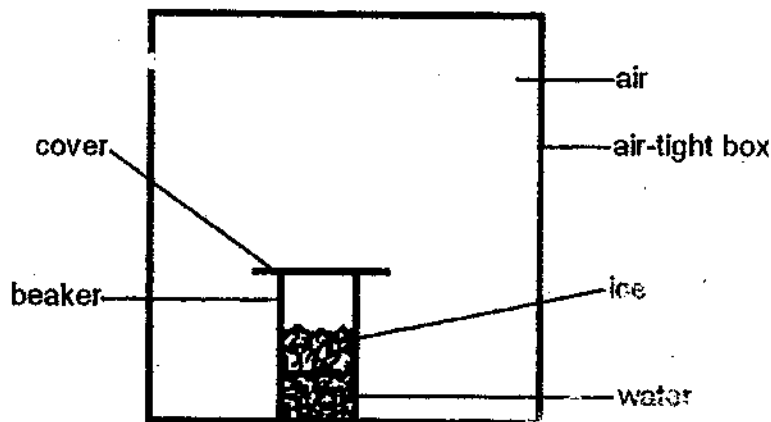

Which one of the following statements is correct about the air in the box?

- 1) The air will gain heat and expand.
- 2) The air will lose heat and become cooler.
- 3) The air will gain heat and become warmer.
- 4) Coldness is transferred from the ice to the air.

28. Gina lowered an empty cup and a small ball into a basin of water until the cup touched the bottom of the basin. She observed that the water level inside the cup was not the same as the water level in the basin. The ball still floated on the water as shown in diagram below.

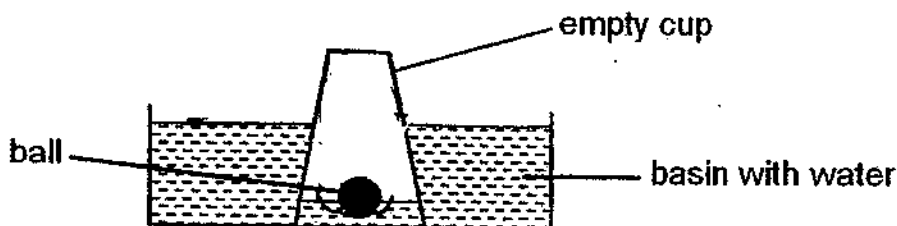

What could be the main reason for the difference in the water level inside and outside the cup?

- 1) The air trapped in the cup occupied space.
- 2) The ball pushed the water out from the cup.
- 3) The air trapped in the cup dissolved in the water.
- 4) The ball in the cup occupied space.

~ End of Booklet A ~

26. Jasmy wanted to find out if the position of the torch and the pen would affect the length of the shadow cast on the screen. She marked 6 points on the table in front of the screen and placed a torch at X and a pen at Y, as shown in the diagram below.

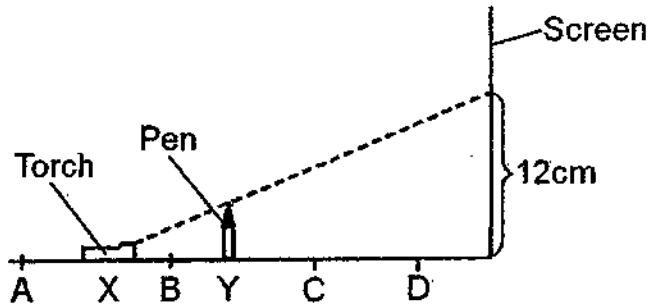

When she switched on the torch, she observed a 12cm long shadow of the pen cast on the screen. Jasmy then placed the torch and the pen at different positions and recorded her observations in the table as shown below.

Which of the following could she have observed?

	Position of torch	Position of pen	Length of the shadow cast (cm)
1)	A	Y	15
2)	B	Y	10
3)	X	B	10
4)	X	C	8

SINGAPORE CHINESE GIRLS' SCHOOL (PRIMARY)

SECOND SEMESTRAL ASSESSMENT

NAME: _____ ()

DATE: _____

CLASS: PRIMARY 4 SY / C / G / SE / P

Parent's Signature:

SCIENCE

BOOKLET B

	Total Actual Marks	Total Possible Marks
Booklet A		56
Booklet B		44
Total		100

14 questions

44 marks

Total time for Booklets A & B: 1 h 45 min

DO NOT OPEN THIS BOOKLET UNTIL YOU ARE TOLD TO DO SO.

FOLLOW ALL INSTRUCTIONS CAREFULLY.

Part II (44 marks)

Answer all the following questions.

29. Study the diagram below.

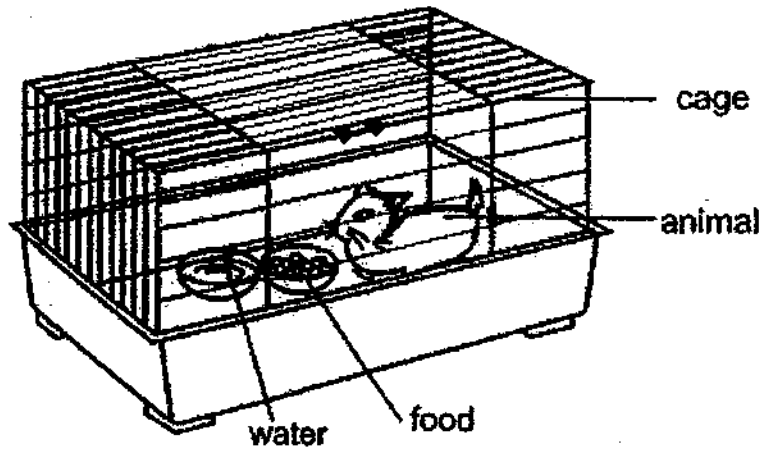

- a) ^{circle} **Circle** what happened to the ^{amount} ~~amount~~ of food in the bowl after a few days. [1]

increase	decrease	remain the same
----------	----------	-----------------

- b) Based on the diagram above, name one substance this animal needs so that it remains alive. [1]

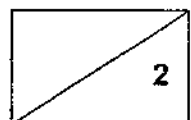

30. Classify the following animals according to the number of stages in their life cycles. [2]



frog



grasshopper



beetle

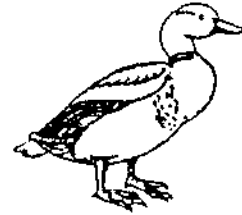

duck

Three stages	Four stages

31. The diagram shows part of the human digestive system.

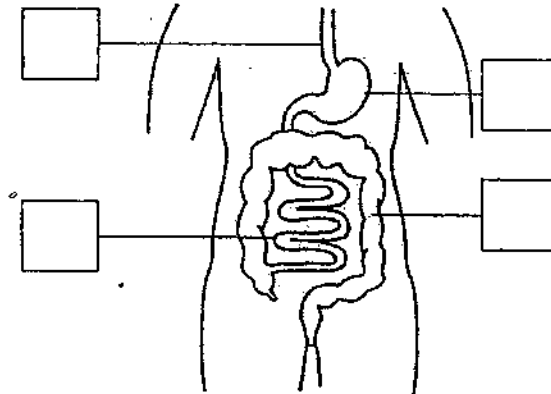

a) Tick one box to show where the stomach is. [1]

b) Fill in the blank below using the following helping words. [1]

small intestine	large intestine	gullet	mouth
-----------------	-----------------	--------	-------

Food from the stomach is next passed on to the _____

c) Name any 2 parts of the system where digestive juices are produced. [1]

32. The diagram below shows two plants.

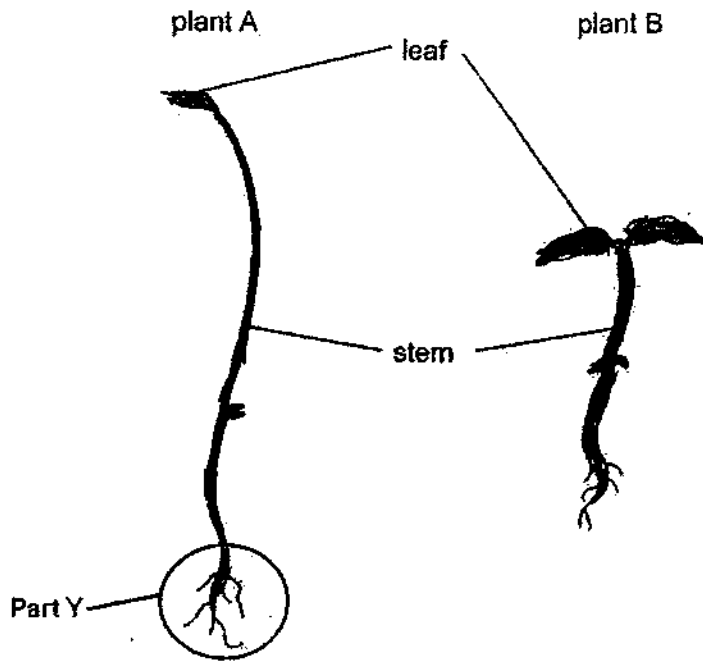

a) What is one difference between the stem of plant A and the stem of plant B?

The stem of plant A is _____ than the stem of the plant B. [1]

b) The leaves help both plants make _____ in the light. [1]

c) When part 'Y' is removed, the plant died. Explain. [1]

33. Yan Hui placed a metal rod and a plastic rod into a tank of boiling water as shown below. Equal amounts of wax were put on both rods.

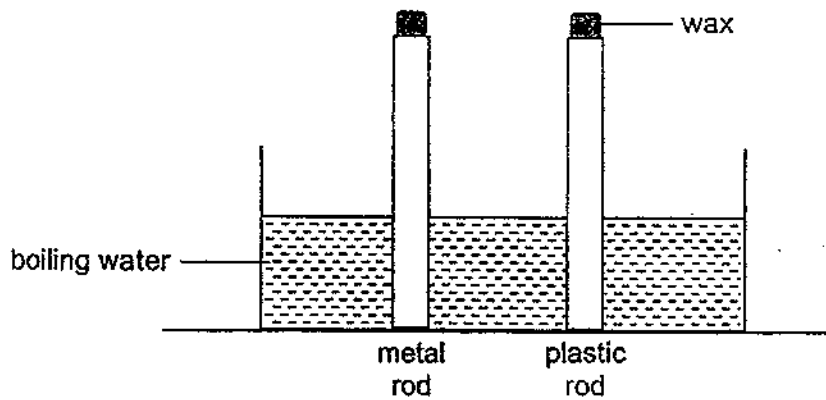

a) What would she observe and why? [2]

The wax on the metal rod melted _____ than the wax on the plastic rod as metal is a _____ conductor of heat.

b) Yan Hui wants her ice cream to remain frozen for as long as possible. Should she use a metal or plastic container to keep her ice cream in?

Explain your answer. [2]

34. Ahmad left a plate of mee rebus in a warm place at the kitchen. Ahmad noticed that the plate of mee rebus looked the same but gave off a bad sour smell the next day. It had turned bad.



a) Which group of living things caused the mee rebus to turn bad? [1]

b) What would happen if Ahmad had put the plate of mee rebus in the refrigerator instead? Explain your answer. [2]

35. The flow chart below shows the characteristics of Plants A, B, C and D.

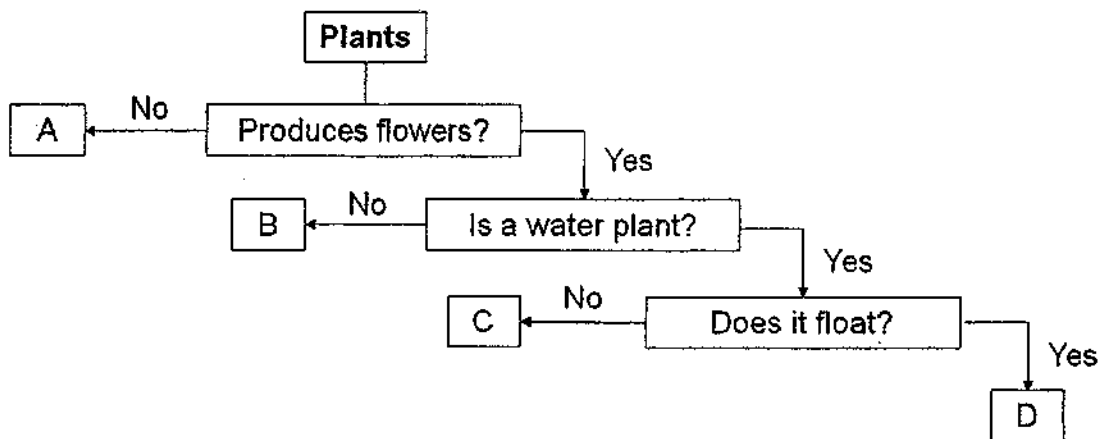

Felicia observed a living thing, X, and recorded her observations in her notebook.

- X grows in water.
- X does not produce flowers.

a) Which plant, A, B, C or D is X most likely to be? [1]

Felicia found another plant, Y, growing in the school garden as shown below.

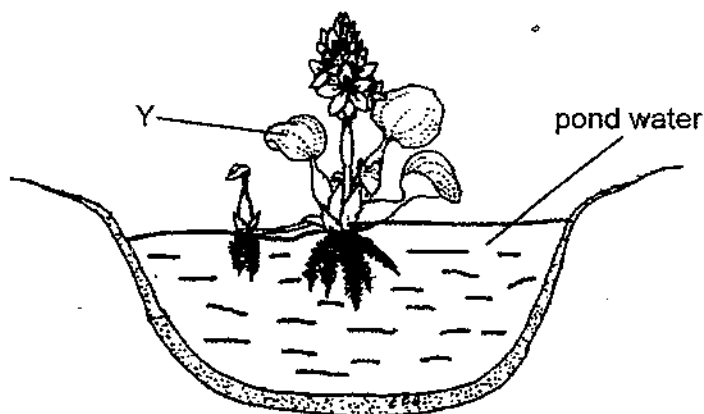

b) Which plant, A, B, C or D can Plant Y be grouped with? [1]

c) Based on the flow chart above, explain your answer in (b). [1]

36a. Mary was given four funnels, labelled P, Q, R and S. She was asked to find out which one of these funnels would allow water to flow through it most quickly. She poured some water into each funnel using the following set-ups and started the stop watch to find out how long the water took to flow into each flask.

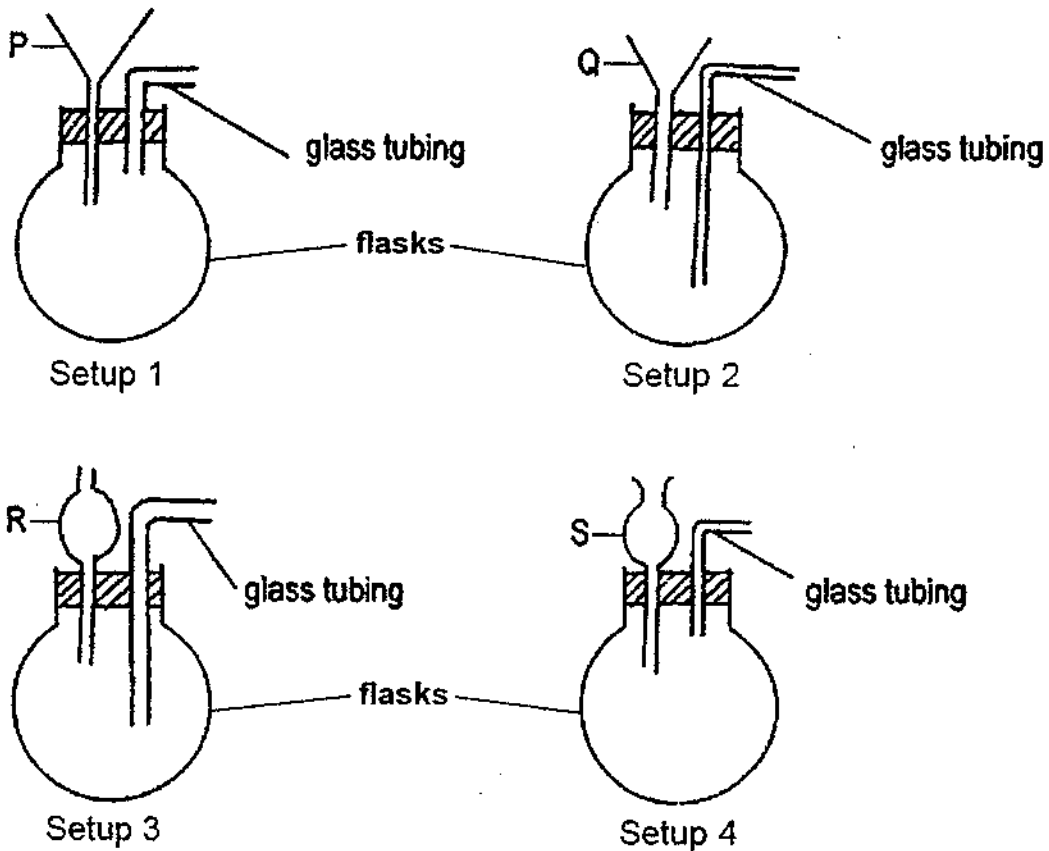

Mary's teacher told her to use the glass tubing of the same size for all setups so that it would be a fair test. Why is this so? [1]

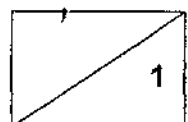

36b. Jason made a hole on the top of a milk can so that he can pour out the milk.

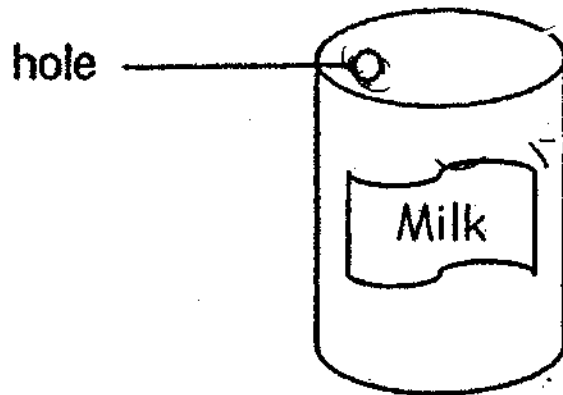

Jason tried pouring the milk out but found that it flowed out very slowly.

- (i) Without enlarging the hole or opening the can, what could Jason do so that the milk could flow out faster? [1]

- (ii) Explain how the suggestion in (a) would allow the milk to flow out more easily? [2]

37. Mrs Lee wanted to find out which one of the 4 materials, A, B, C or D is able to absorb the most amount of water. She placed the 4 materials over 4 water troughs respectively and poured 50ml of water onto each of the materials. The diagrams below show the amount of water that was able to pass through the materials after 30 minutes.

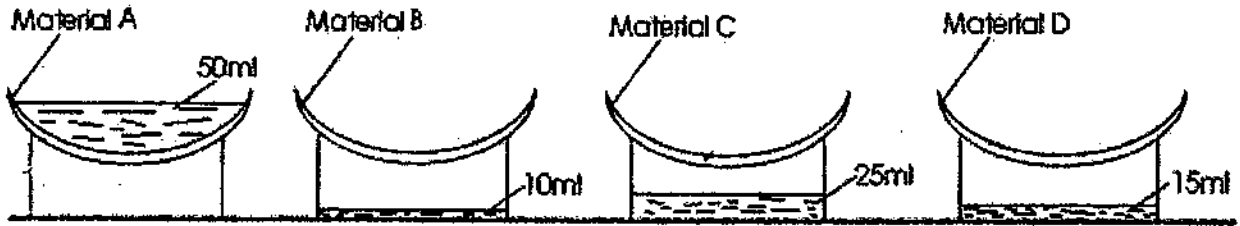

a) Arrange the materials according to how well they absorb water.

Write down A, B, C and D in the boxes below.

[2]

Most absorbent → Least absorbent

--	--	--	--

b) Based on your answer in (a), which material, A, B, C or D, is most suitable to make part J and K? Give a reason for your answer.

[2]



Part	Material used	Reason
J		
K		

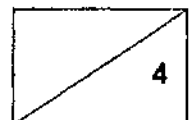

38. On a beach one night, Rahim observed a turtle moving on the sand.

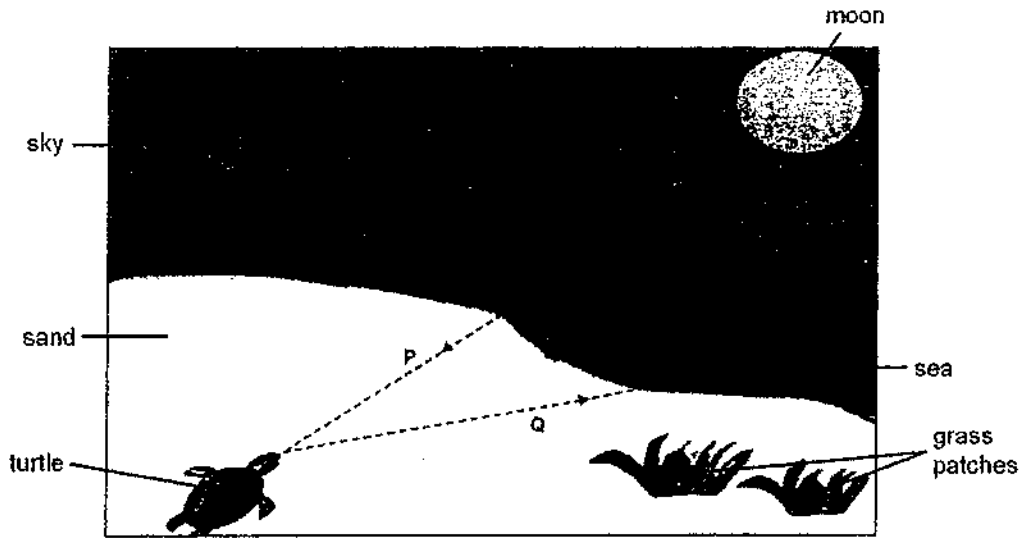

a) Which set of arrows, P or Q, correctly shows how the turtle could see the moon? [1]

b) Draw another set of arrows to show how the turtle can see the grass in the moonlight in the diagram below. [1]



B - 10

(Go on to the next page)

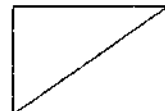

39. Jay tied a packet of marbles on Wire A on a hot day and observed it every hour. After four hours, he observed that the packet of marbles touched the ground as shown in the diagram below.

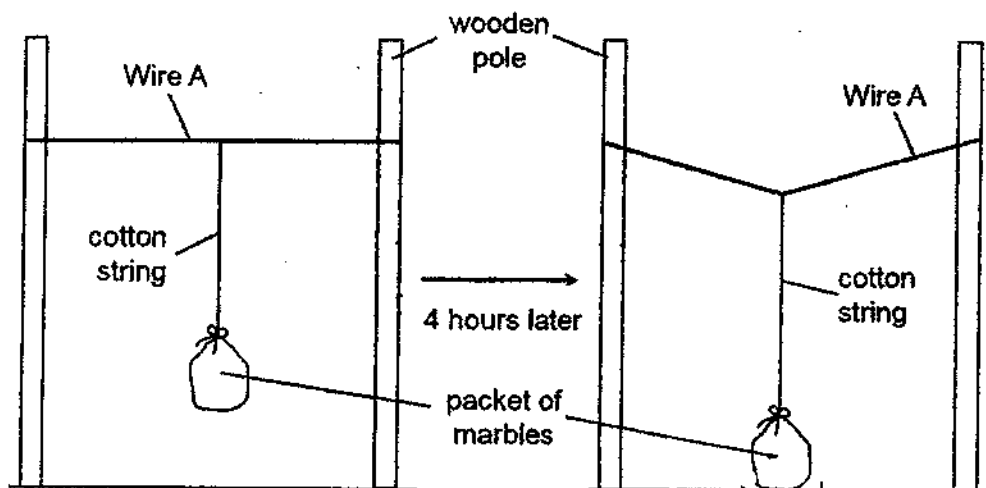

- a) The next day, he repeated the experiment by replacing Wire A with Wire B under the same conditions. However, the packet of marbles did not touch the ground. What was Jay trying to find out? [1]

- b) Tick **two** variables that do not affect the results of the experiment. [2]

Variable	Will not affect result
Length of wire	
Mass of marbles	
Thickness of wire	
Colour of marbles	
Colour of the wooden poles	

- c) Which wire, A or B, should Jay use to make an outdoor clothes line? [1]

40. The diagram below shows a light sensor which is used to count the number of people entering an exhibition hall.

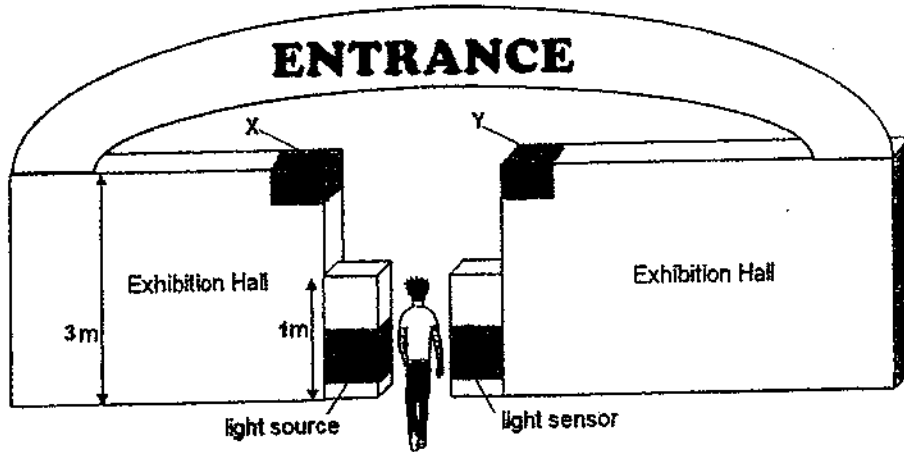

The space between the light source and sensor only allows one person to enter the exhibition hall each time.

When the person enters the exhibition hall, the light is blocked. The readings of the sensor are recorded in the graph below.

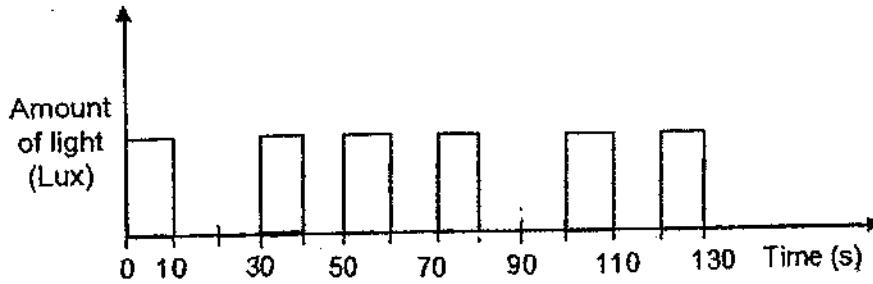

- a) How many people have gone into the exhibition hall in the first 80 seconds? [1]

- b) If the sensor and light source are moved to Part X and Part Y, the sensor cannot accurately record the number of people entering the exhibition hall. Why? [2]

- c) Which property of light allows this light sensor to work? [1]

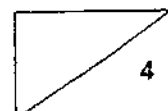

41. Mrs Fong carried out an experiment using two cups, A and B, made of different materials, A and B, respectively. She filled both cups with the same amount of water at a temperature of 25°C and placed them each into a basin of hot water at 90°C as shown in the diagram below.

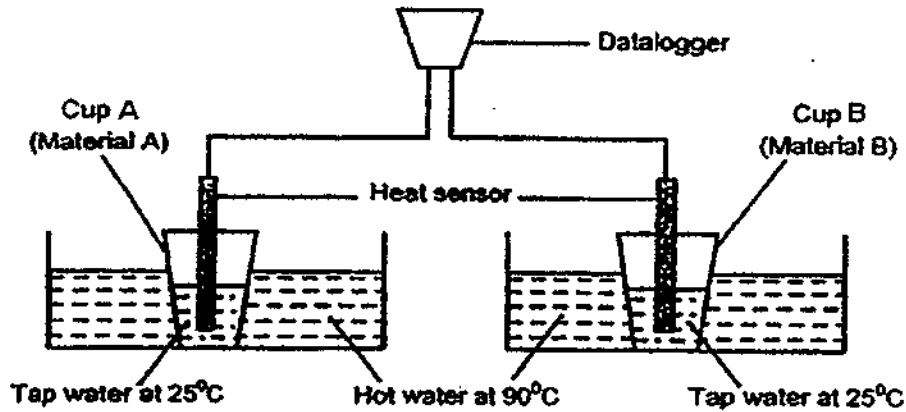

Mrs Fong then used a datalogger to measure and recorded the temperature of water inside cups A and B for ten minutes. The results are shown below.

Cup	Temperature of water inside the cup		
	0 min	5 min	10 min
A	25°C	40°C	50°C
B	25°C	35°C	75°C

- a) Which material, A or B, is a better conductor of heat? Explain your answer using the results. [1]

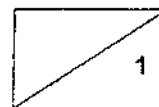

- b) In the diagram below, draw an arrow to show how heat is transferred between the water in the basin and the water in the cup. [1]

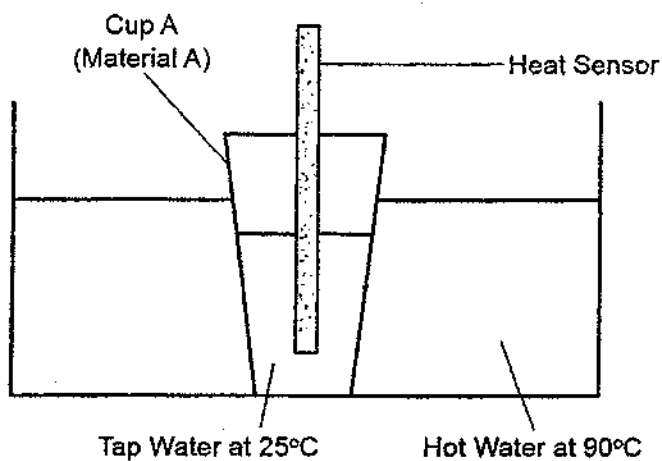

- c) When will the heat transfer between the hot water in the basin and the water in the cup stop? [1]
-

42. In the diagram below, Lynn hangs a wooden pyramid with a square base directly below a lamp which is fixed on the ceiling.

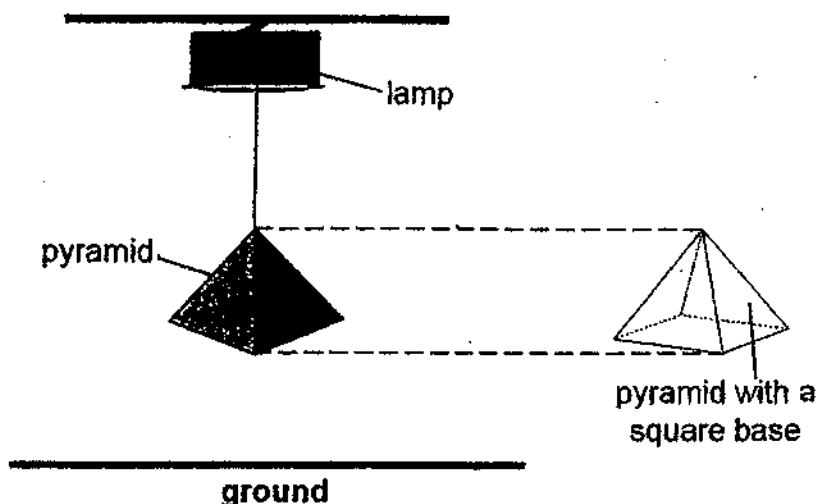

- a) Draw how the shadow would look like on the ground in the box below. [1]

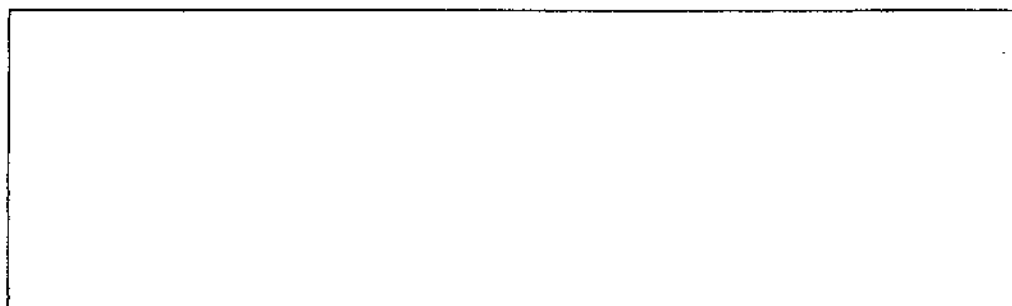

- b) To make a bigger shadow on the ground, what can Lynn do to the string?
Circle your answer. [1]

Cut the string	Lengthen it	Shorten it
----------------	-------------	------------

- c) When the pyramid is turned upside down, its distance from the ground remains the same as in (a). Will its shadow be bigger, smaller or the same as in (a)? [1]

~ End of Booklet B ~

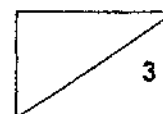

ANSWER KEY



YEAR : 2021
LEVEL : PRIMARY 4
SCHOOL : SINGAPORE CHINESE GIRLS' SCHOOL
SUBJECT : SCIENCE
TERM : SECOND SEMESTRAL EXAMINATION

BOOKLET A

Q1	2	Q2	4	Q3	3	Q4	3	Q5	1
Q6	3	Q7	1	Q8	1	Q9	2	Q10	4
Q11	3	Q12	3	Q13	4	Q14	2	Q15	4
Q16	3	Q17	4	Q18	2	Q19	2	Q20	1
Q21	3	Q22	4	Q23	1	Q24	2	Q25	1
Q26	4	Q27	2	Q28	1				

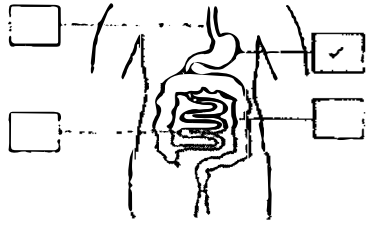
BOOKLET B

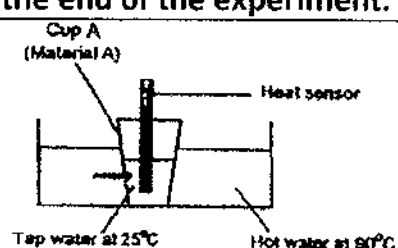
Q29	a)	Decrease
	b)	Air/Water/Food
Q30	Three stages	
	Frog Duck Grasshopper	
Q31	Four stages	
	Beetle	
Q31	a)	
	b)	small intestine
	c)	mouth, stomach and small intestine
Q32	a)	taller / thinner / longer
	b)	food
	c)	The plant has no roots to take in /absorb
Q33	a)	faster/sooner/quicker in shorter, better conductor of heat.
	b)	Plastic
Q34	a)	Bacteria/Decomposers/Fungi
	b)	Mee Reebus will not turn sour OR Bacteria/ Fungi/ Decomposers will not grow. AND Bacteria/ Fungi /Decomposers need warmth to grow but the fridge is too cold.

Q35	a)	A
	b)	D
	c)	Y produces flowers, is a water plant and can float on water.
Q36	a)	The width of the glass tubing can affect the amount of air in the flask that escape / the speed the water flows through the funnel.
	b)i)	Make an extra hole.
	ii)	The extra hole will allow air to enter the can and push milk out / occupy the space of the milk so that the milk can come out.
Q37	a)	B D C A
	b)	J – B. It is able to absorb the most water. K - A. It is waterproof / cannot absorb any water.
Q38	a)	P
	b)	
Q39	a)	To find out if Wire A or Wire B expands more upon heating.
	b)	Tick only: • Colour of marbles • Colour of wooden poles
	c)	Wire B
Q40	a)	3 Count the dips – that is when light is blocked.
	b)	Many people are too short to block the light of the sensor. OR The sensors are too high for its lights to be blocked by people.
	c)	Light travels in a straight line.
Q41	a)	B. B is a better conductor of heat because tap water/ water in the cup gained heat faster to reach a higher temperature at the end of the experiment.
	b)	 Any arrow from the water in the basin to the tap water.
	c)	When both tap water and hot water in basin reach the same temperature.
Q42	a)	square 
	b)	Shorten it
	c)	Bigger